

CYLINDER ACCESSORIES

CYLINDER LIFTING HANDLES

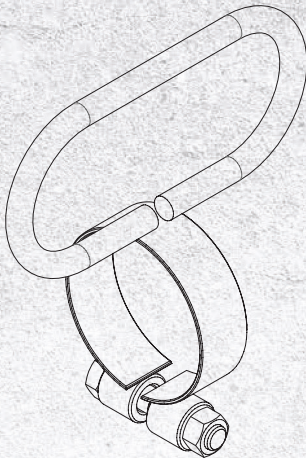

- Designed for ease of carrying
- Provides better control for positioning cylinder

Model Number	For Cylinders
LH25T34	H2504 through H2514
LH30T40	H3008, HD3008, HD3014, HC2002T, HC2006T
LH30T45	HC3002T, HC3006T, HD3007, HDC3010
LH55T49	HLN5504 through HLN5512

CLEVIS AND TANGS

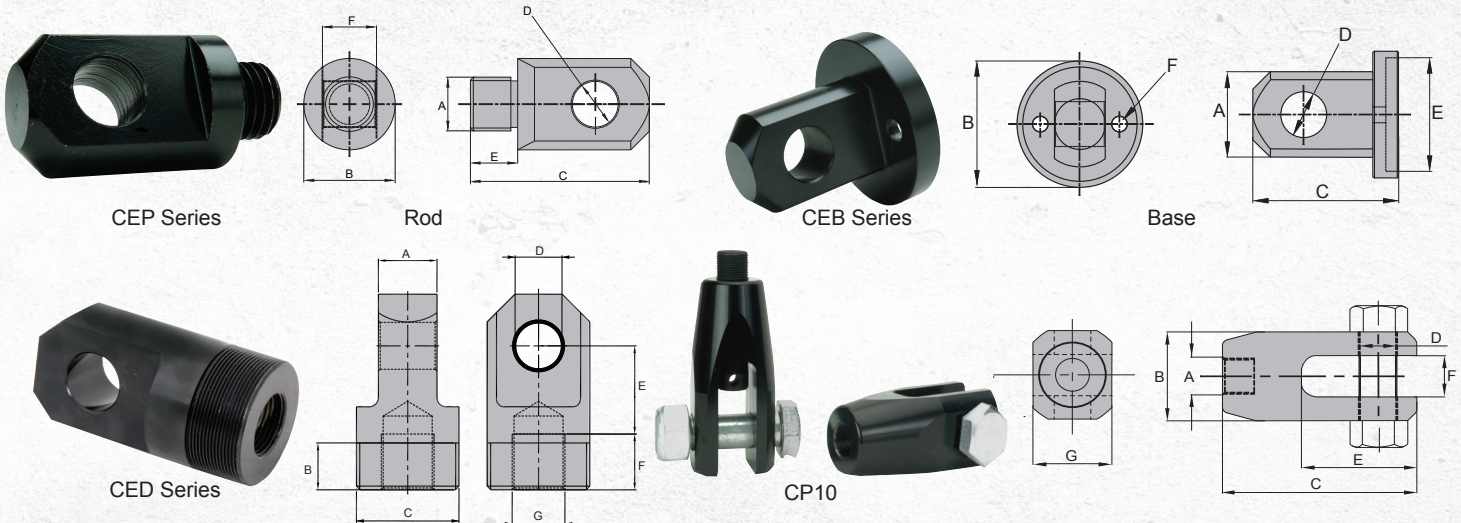

Application	For use with Cylinder Capacity (tons)	Model Number	Dimensions (in)						
			A	B	C	D	E	F	G
Rod	5	CEP05	3/4"-16UNF	1.13	2.25	0.63	0.62	0.56	-
	10	CEP10	1"-8UNC	1.69	3.31	0.88	0.75	1.00	-
	15	CEP15	1"-8UNC	1.69	3.31	0.88	0.75	1.00	-
	25	CEP25	1 1/2"-16	2.25	3.81	1.25	0.87	1.50	-
Base	5	CEB05	1.52	1.75	2.13	0.63	0.26	1.13	-
	10	CEB10	2.28	2.50	2.87	0.88	1.69	0.32	-
	15	CEB15	2.77	3.00	2.87	0.88	1.69	0.38	-
	25	CEB25	3.40	3.75	3.37	1.25	2.25	0.56	-
Rod & Base	9	CED09	1	1	1-11/16"-18	0.75	1.31	0.94	3/4"-16
	16	CED16	1.25	1	2-3/16"-16	1	1.88	1.19	1 1/8" 12
	HP1006 only	CP10*	M30x2	2.95	6.30	1.18	3.74	1.38	2.56

* 2-pc set with an adapter

BASES

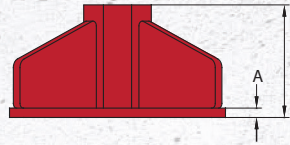
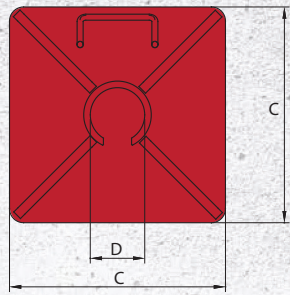

For use with Cylinder Capacity (tons)	Model Number	Dimensions (in)			
		A	B	C	D
5	CB05	0.32	4.65	7.87	1.54
10	CB10	0.39	4.72	9.06	2.28
15	CB15	0.47	4.80	10.00	2.76
25	CB25	0.63	4.96	11.02	3.41

SADDLES



SD SERIES



SDT10



HTD10

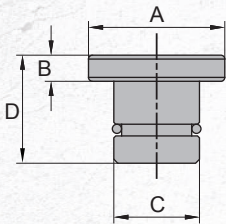

FIGURE #1

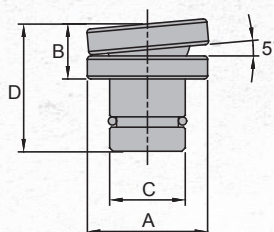

FIGURE #2

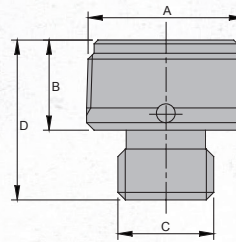

FIGURE #3

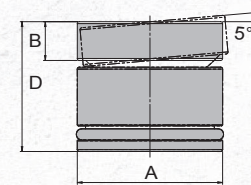

FIGURE #4

Saddle Type	Model Number	Capacity (ton)	For Cylinder(s)	Dimensions (in)				Figure Number
				A	B	C	D	
Tilt	SDT05	5	H05	0.98	1.22	-	0.63	2
	SDT10	10	H10	1.38	1.50	-	0.74	2
	SDT15	15	H15	1.50	1.57	-	0.73	2
	SDT25	25	H25	1.97	1.6	-	1.29	2
	SDT55	55-100	H55, HD55, H75, HD75, H100, HLN55 and HLN100	2.80	1.29	0.67	0.51	2
	SDTG100	100	HG100/HDG100	2.95	2.64	1.71	0.79	4
	SDTG150	150	HG150/HDG150	3.70	2.71	1.77	0.77	4
	SDTG200	200	HG200/HDG200	4.45	3.25	1.95	1.10	4
Grooved	SDT200	200	HLN 150/HLN200	5.12	1.77	1.02	0.53	4
	SD05	5	H05	0.98	0.81	-	0.24	1
	SD10	10	H10	1.38	1.06	-	0.24	1
	SD15	15	H15	1.50	1.18	-	0.28	1
Threaded	SD25	25	H25	1.97	1.14	-	0.28	1
	HTD10	10	HT1006 & HT1010	1 1/4"-11.5NPTF	0.95	1"-8UNC	1.77	3